

Product Specification

1.25Gb/s BIDI SFP TX-1550nm/RX-1310nm
40km Optical Transceiver

P/N: 1G-SFP-D53-40



Features

- Hot Pluggable SFP form factor
- Operating data rate 1.25Gbps
- Single +3.3V power supply
- BIDI LC/UPC type pluggable optical interface
- 1550nm DFB laser transmitter and PIN photo-detector
- Up to 40km on 9/125µm SMF
- Low power dissipation
- Metal enclosure, for lower EMI
- Built-in digital diagnostic function
- Commercial temperature range 0°C to 70°C

Compliance

- SFP MSA
- Compliant with SFP Electrical MSA SFF-8431
- Compliant with SFP Mechanical MSA SFF-8432
- SFF-8472
- IEEE 802.3ae
- RoHS

Applications

- Switches with SFP ports
- Router with SFP Ports
- Server or Network Adapter Card
- Optical Transmission System
- Other devices with SFP Ports

Description

The 1G-SFP-D53-40 is a high-performance BiDi SFP transceiver designed for extended-range Gigabit Ethernet applications over single-mode fiber (SMF). It operates on two wavelengths: 1550nm for transmitting data and 1310nm for receiving data, enabling bidirectional communication over a single fiber strand. This transceiver supports data rates of up to 1.25Gbps and is fully compliant with the IEEE 802.3 Gigabit Ethernet standard and SFP Multi-Source Agreement (MSA). With a transmission distance of up to 40 kilometers, it is ideal for long-distance point-to-point links, metropolitan area networks (MANs), and enterprise network backbones.

The 1G-SFP-D53-40 offers a cost-effective and space-saving solution by reducing the need for additional fiber infrastructure, making it perfect for high-density deployments. Its hot-pluggable design ensures easy installation and maintenance, while its low power consumption enhances energy efficiency. Equipped with digital diagnostics monitoring (DDM) capabilities, the transceiver provides real-time performance tracking, simplifying network management and troubleshooting. Whether deployed in telecommunications, data center interconnects, or enterprise networks, the 1G-SFP-D53-40 delivers reliable performance and flexibility for long-distance bidirectional communication needs.

Product performance Specifications

1. Basic Product Characteristics

Parameter	Symbol	Min	Typ.	Max	Unit
Storage Temperature	T_s	-40	-	+85	°C
Supply Voltage	V_{CC}	-0.3	-	3.6	V
Relative Humidity	RH	5	-	95	%
Damage Threshold	THd	5	-		dBm
Operating Case Temperature	TOP	0		+70	oC
Power Supply Voltage	V_{CC}	3.135	3.3	3.465	V
Data Rate			1.25		Gb/s
Control Input Voltage High		2		V_{CC}	V
Control Input Voltage Low		0		0.8	V
Link Distance (SMF)	D			40	km

2. Product Optical and Electrical Characteristics

Parameter	Symbol	Min	Typ.	Max	Unit
Transmitter					
Single-ended Input Voltage Tolerance	V_{CC}	-0.3		4.0	V
Differential Input Voltage Swing	$V_{in,pp}$	200		2400	mVpp
Differential Input Impedance	Z_{in}	90	100	110	Ohm
Transmit Disable Assert Time				5	us
Transmit Disable Voltage	V_{dis}	$V_{CC}-1.3$		V_{CC}	V
Transmit Enable Voltage	V_{en}	$V_{EE}-0.3$		0.8	V
Center Wavelength	λ_C	1530	1550	1570	nm
Spectrum Bandwidth(RMS)	σ			1	nm
Side Mode Suppression Ratio	SMSR	30			dB
Average Optical Power ₁	P_{AVG}	-5		0	dBm
Optical Extinction Ratio	ER	9			dB
Transmitter OFF Output Power	P_{OFF}			-45	dBm
Transmitter Eye Mask ₂	Compliant with 802.3z(class 1 laser safety)				
Power Consumption	P			0.86	W
Supply Current	I_{cc}			280	mA
Receiver					
Differential Output Voltage Swing	$V_{out,pp}$	500		900	mVpp
Differential Output Impedance	Z_{out}	90	100	110	Ohm
Data output rise/fall time	T_r/T_f		100		ps
LOS Assert Voltage	V_{losH}	$V_{CC}-1.3$		V_{CC}	V
LOS De-assert Voltage	V_{losL}	$V_{EE}-0.3$		0.8	V
Center Wavelength	λ_C	1260	1310	1360	nm
Receiver Sensitivity (Average Power) ₃	Sen.			-23	dBm
Input Saturation Power (overload)	P_{sat}	-1			dBm
LOS Assert ₄	LOSA	-36			dB
LOS De-assert ₄	LOSD			-25	dBm
LOS Hysteresis	LOSH	0.5	2	6	dBm

Note1: Measure at 2⁷- 1 NRZ PRBS pattern

Note2: Transmitter eye mask definition

Note3: Measured with Light source 1310nm, ER=9dB; BER = < 10⁻¹² @PRBS=2⁷- 1 NRZ

Note4: When LOS de-asserted, the RX data+/- output is High-level (fixed)

Recommended Host Board Power Supply Circuit

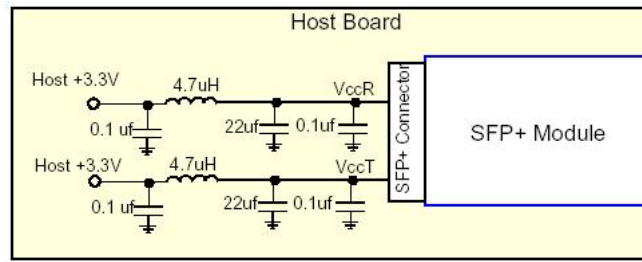

Figure 1: Recommended Host Board Power Supply Circuit

Recommended Interface Circuit

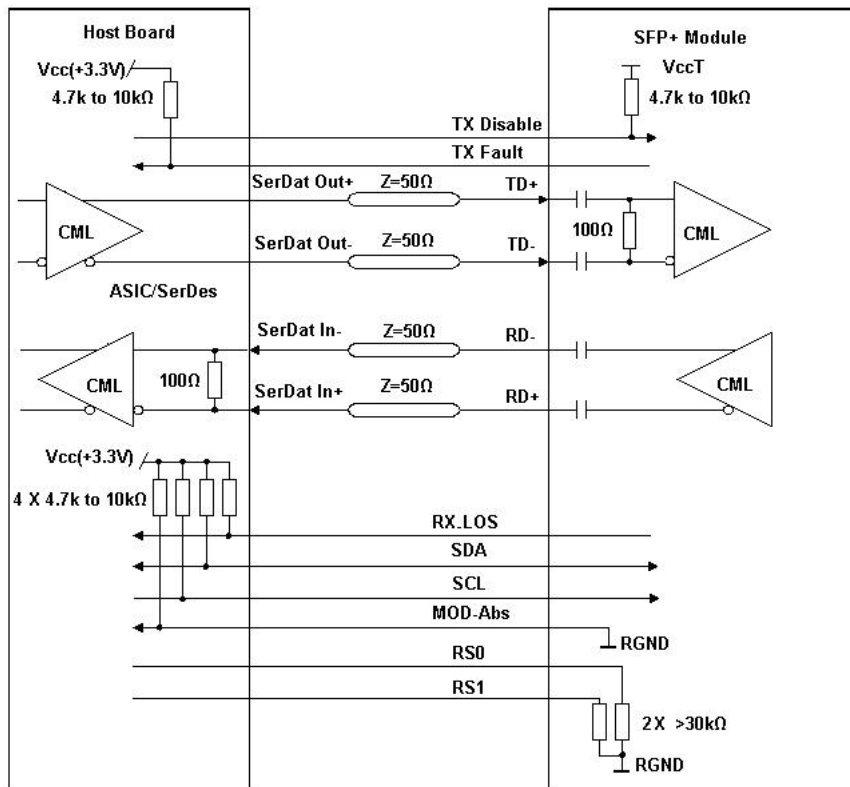

Figure2: Recommended Interface Circuit

Pin-out Definition

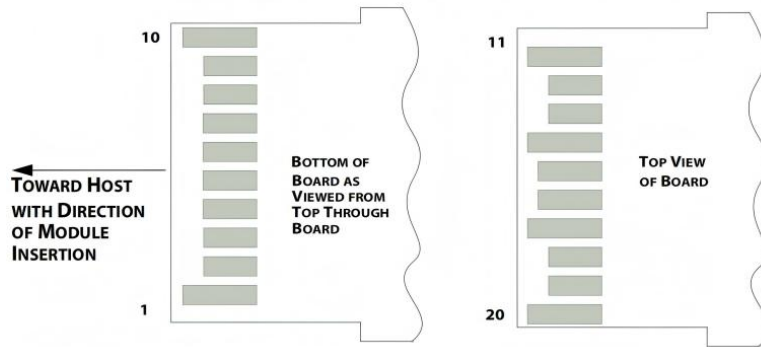

Figure3:Pin view

Pin Function Definitions

Pin	Logic	Symbol	Description	Note
1		VeeT	Module Transmitter Ground	1
2	LVTTTL-O	TX_Fault	Module Transmitter Fault	2
3	LVTTTL-I	TX_Disable	Transmitter Disable; Turns off transmitter laser output	3
4	LVTTTL-I/O	SDA	2-wire Serial Interface Data Line (Same as MOD-DEF2 as defined in the INF-8074i)	4
5	LVTTTL-I/O	SCL	2-wire Serial Interface Clock (Same as MOD-DEF1 as defined in the INF-8074i)	4
6		MOD_ABS	Module Absent, connected to VeeT or VeeR in the module	5
7	LVTTTL-I	RS0	Adaptive multi-rate operation	6
8	LVTTTL-O	RX_LOS	Receiver Loss of Signal Indication (In FC designated as RX_LOS, in SONET designated as LOS, and in Ethernet designated at Signal Detect)	2
9	LVTTTL-I	RS1	Adaptive multi-rate operation	6
10		VeeR	Module Receiver Ground	1
11		VeeR	Module Receiver Ground	1
12	CML-O	RD-	Receiver Inverted Data Output	
13	CML-O	RD+	Receiver Non-Inverted Data Output	
14		VeeR	Module Receiver Ground	1
15		VccR	Module Receiver 3.3 V Supply	
16		VccT	Module Transmitter 3.3 V Supply	
17		VeeT	Module Transmitter Ground	1
18	CML-I	TD+	Transmitter Non-Inverted Data Input	
19	CML-I	TD-	Transmitter Inverted Data Input	
20		VeeT	Module Transmitter Ground	1

- Note1:** The module signal ground pins, VeeR and VeeT, shall be isolated from the module case.
- Note2:** This pin is an open collector/drain output pin and shall be pulled up with 4.7kΩ-10kΩ to Host_Vcc on the host board. Pull ups can be connected to multiple power supplies, however the host board design shall ensure that no module pin has voltage exceeding module VccT/R + 0.5V.
- Note3:** This pin is an open collector/drain input pin and shall be pulled up with 4.7kΩ-10kΩ to VccT in the module.
- Note4:** See SFF-8431 4.2 2-wire Electrical Specifications.
- Note5:** This pin shall be pulled up with 4.7kΩ-10kΩ to Host_Vcc on the host board.
- Note6:** Connect with 30kΩ load pulled down to GND in the module.

Monitoring Specification

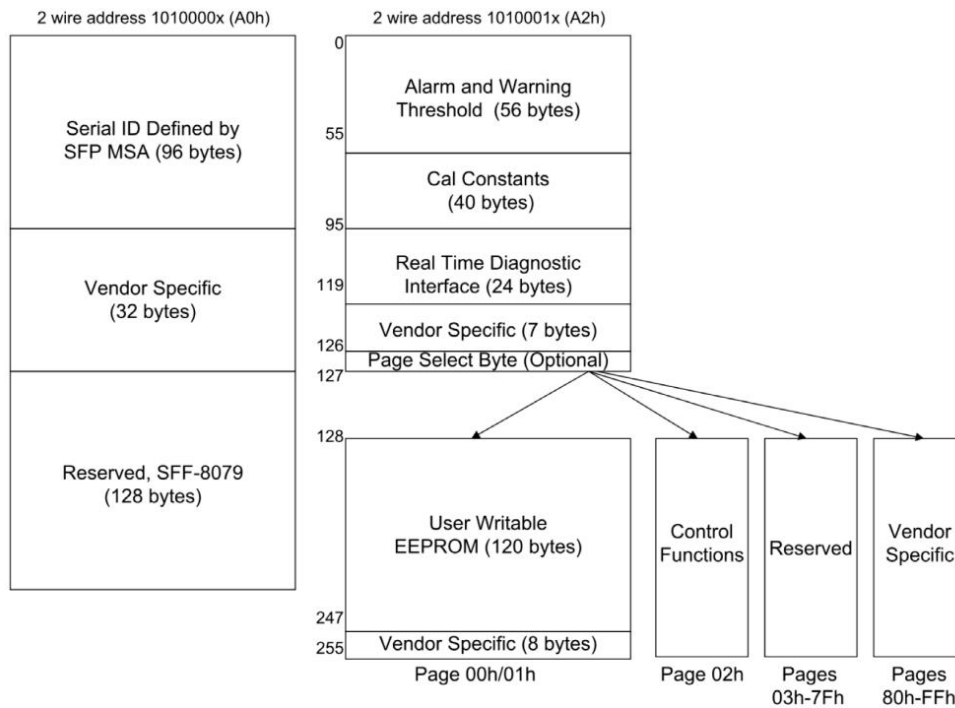

Figure4:Memory map

Memory map Table

A0h	Bytes	Name	Description
A0h ID Fields			
0	1	Identifier	Type of transceiver
1	1	Ext. Identifier	Extended identifier of type of transceiver
2	1	Connector	Code for connector type
3-10	8	Transceiver	Code for electronic or optical compatibility
11	1	Encoding	Code for high speed serial encoding algorithm
12	1	Signaling Rate, Nominal	Nominal signaling rate, units of 100 MBd.
13	1	Rate Identifier	Type of rate select functionality

14	1	Length (SMF,km) or Copper Cable Attenuation	Link length supported for single-mode fiber, units of km, or copper cable attenuation in dB at 12.9 GHz
15	1	Length (SMF) or Copper Cable Attenuation	Link length supported for single-mode fiber, units of 100 m, or copper cable attenuation in dB at 25.78 GHz
16	1	Length (50 um, OM2)	Link length supported for 50 um OM2 fiber, units of 10 m
17	1	Length (62.5 um, OM1)	Link length supported for 62.5 um OM1 fiber, units of 10 m
18	1	Length (OM4 or copper cable)	Link length supported for 50um OM4 fiber, units of 10 m. Alternatively, copper or direct attach cable, units of m
19	1	Length (OM3) or Cable length, additional	Link length supported for 50 um OM3 fiber, units of 10 m. Alternatively, copper or direct attach cable multiplier and base value
20-35	16	Vendor name	SFP vendor name (ASCII)
36	1	Transceiver	Code for electronic or optical compatibility
37-39	3	Vendor OUI	SFP vendor IEEE company ID
40-55	16	Vendor PN	Part number provided by SFP vendor (ASCII)
56-59	4	Vendor rev	Revision level for part number provided by vendor (ASCII)
60-61	2	Wavelength	Laser wavelength (Passive/Active Cable Specification Compliance)
62	1	Fibre Channel Speed 2	Transceiver's Fibre Channel speed capabilities
63	1	CC_BASE	Check code for Base ID Fields (addresses 0 to 62)
64-65	2	Options	Indicates which optional transceiver signals are implemented
66	1	Signaling Rate, max	Upper signaling rate margin, units of %
67	1	Signaling Rate, min	Lower signaling rate margin, units of %
68-83	16	Vendor SN	Serial number provided by vendor (ASCII)
84-91	8	Date code	Vendor's manufacturing date code
92	1	Diagnostic Monitoring Type	Indicates which type of diagnostic monitoring is implemented (if any) in the transceiver
93	1	Enhanced Options	Indicates which optional enhanced features are implemented (if any) in the transceiver
94	1	SFF-8472 Compliance	Indicates which revision of SFF-8472 the transceiver complies with.
95	1	CC_EXT	Check code for the Extended ID Fields (addresses 64 to 94)
96-127	32	Vendor Specific	Vendor Specific EEPROM
128-255	128	Reserved	Reserved (was assigned to SFF-8079)
A2h ID Fields			
00-01	2	Temp High Alarm	MSB at low address
02-03	2	Temp Low Alarm	MSB at low address
04-05	2	Temp High Warning	MSB at low address
06-07	2	Temp Low Warning	MSB at low address
08-09	2	Voltage High Alarm	MSB at low address
10-11	2	Voltage Low Alarm	MSB at low address
12-13	2	Voltage High Warning	MSB at low address
14-15	2	Voltage Low Warning	MSB at low address
16-17	2	Bias High Alarm	MSB at low address
18-19	2	Bias Low Alarm	MSB at low address

20-21	2	Bias High Warning	MSB at low address
22-23	2	Bias Low Warning	MSB at low address
24-25	2	TX Power High Alarm	MSB at low address
26-27	2	TX Power Low Alarm	MSB at low address
28-29	2	TX Power High Warning	MSB at low address
30-31	2	TX Power Low Warning	MSB at low address
32-33	2	RX Power High Alarm	MSB at low address
34-35	2	RX Power Low Alarm	MSB at low address
36-37	2	RX Power High Warning	MSB at low address
38-39	2	RX Power Low Warning	MSB at low address
40-41	2	Optional Laser Temp High Alarm	MSB at low address
42-43	2	Optional Laser Temp Low Alarm	MSB at low address
44-45	2	Optional Laser Temp High Warning	MSB at low address
46-47	2	Optional Laser Temp Low Warning	MSB at low address
48-49	2	Optional TEC Current High Alarm	MSB at low address
50-51	2	Optional TEC Current Low Alarm	MSB at low address
52-53	2	Optional TEC Current High Warning	MSB at low address
54-55	2	Optional TEC Current Low Warning	MSB at low address
56-91	36	Ext Cal Constants or Additional Enhanced Features	Diagnostic calibration constants for optional External Calibration if External Calibration bit, A0h, byte 92, bit 4 is 1 Additional Enhanced Features advertisement, control and status if External Calibration bit, A0h, byte 92, bit 4 is 0
92-94	3	Reserved	
95	1	CC_DMI	Check code for Base Diagnostic Fields (addresses 0 to 94)
96-105	10	Diagnostics	Diagnostic Monitor Data (internally or externally calibrated)
106-109	4	Optional Diagnostics	Monitor Data for Optional Laser temperature and TEC current
110	1	Status/Control	Optional Status and Control Bits
111	1	Reserved	Reserved (was assigned to SFF-8079)
112-113	2	Alarm Flags	Diagnostic Alarm Flag Status Bits
114	1	Tx Input EQ control	Tx Input equalization level control
115	1	Rx Out Emphasis control	Rx Output emphasis level control
116-117	2	Warning Flags	Diagnostic Warning Flag Status Bits
118-119	2	Ext Status/Control	Extended module control and status bytes
120-126	7	Vendor Specific	Vendor specific memory addresses
127	1	Table Select	Optional Page Select
A2h Page 00-01h			
128-247	120	User EEPROM	User writable non-volatile memory
248-255	8	Vendor Control	Vendor specific control addresses
A2h Page 02h			
128-129	2	Reserved	Reserved for SFF-8690 (Tunable Transmitter)
130	1	Reserved	Reserved for future receiver controls

131	1	Rx Decision Threshold	RDT value setting
132-172	41	Reserved	Reserved for SFF-8690
173-255	83	Reserved	Reserved

Mechanical Dimension

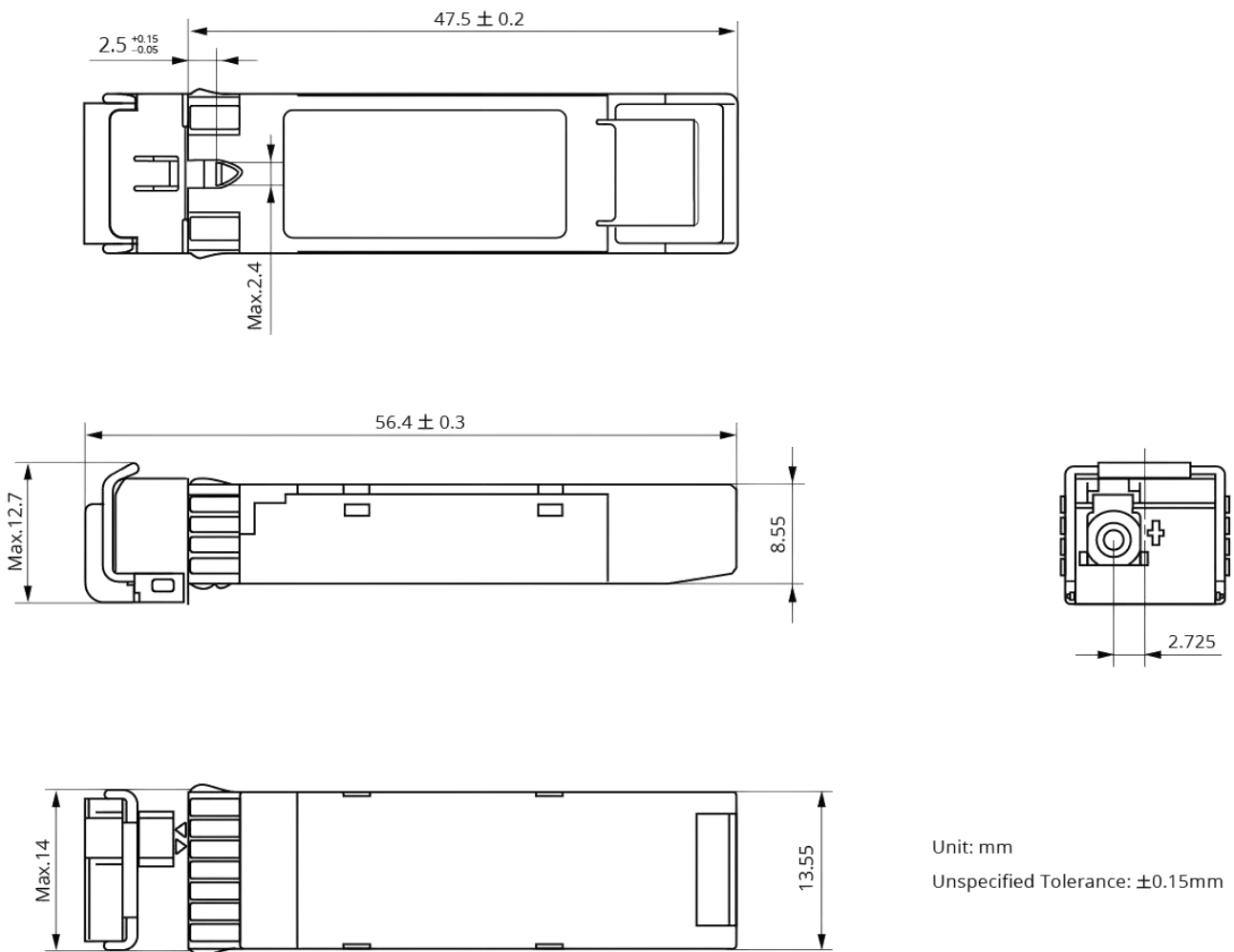

Test Center

1. Performance Testing

Every fiber optic transceiver is thoroughly tested by the LSOLINK Assurance Program, which is equipped with the world's most advanced analytical equipment to ensure that our transceivers meet the industry's international public protocol standards while still functioning flawlessly in your facility.

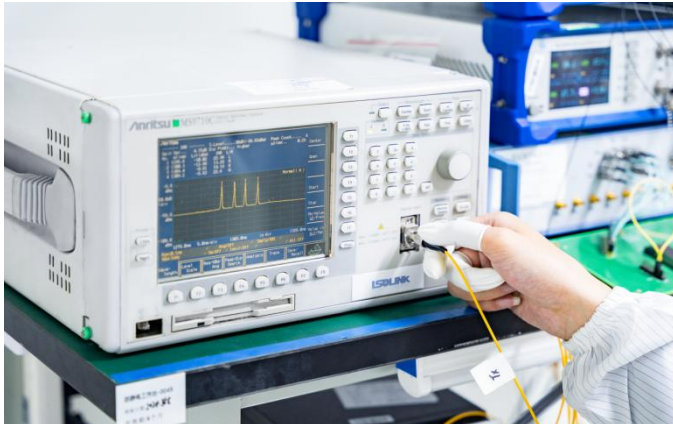

Optical Spectrum Inspection

Using the industry's leading optical spectrum analyser to check in real time that the parameters of the optical transceiver's laser comply with industry standards.

- **Peak:** Peak wavelength and peak level
- **2nd Peak:** Side-mode wavelength and level
- **Mean Wl:** Center wavelength
- **Total Power:** Total power of spectrum
- **SMSR:** Side-Mode Suppression Ratio



Optical Signal Quality Inspection

Using highly efficient sampling oscilloscopes and BERT testers, equipped with an automated test platform to accurately test the signal quality of the transceiver, test records are kept for up to 5 years to ensure the traceability of each transceiver.

- **Eye Mask Margin(NRZ)**
- **TDECQ(PAM4):** transmitter dispersion eye closure
- **OMA:** Optical modulation amplitude
- **BER:** Bit error rate
- **ER:** Extinction Ratio



Flow Pressure Test

Using multi-protocol network traffic analyser with various brands of switches to test the transceiver's ability to transmit at full speed.

- **Bandwidth:** Actual transceiver bandwidth on the port
- **Packet Loss**
- **Packet Errors:** CRC Errors/PCS Errors/Symbol Errors
- **LinkDown Counts**
- **latency**

Above is part of our test bed network equipment. For more information, Please click [download](#) for optical transceiver performance test report.

2. Quality Control

We adopt advanced quality management solutions. Each transceiver is self-inspected, including:20x microscope inspection, 200x microscope inspection, and QC process inspection.



visual inspection



Microscopic inspection: 20X



Microscopic inspection: 200X



Reliability Verification



Optical endface inspection



OQC Inspection

3. Compatibility Testing

Each optical transceiver is tested in LSOLINK's library of compatibility test equipment to ensure perfect compatibility with multiple brands on the market.



Alcatel OS6900-X20



Arista DCS-7060SX2-48YC6-R



Cisco Nexus N9K-C9318YC-EX



Dell S4048-ON



Huawei S6720-30L-HI-24S



Juniper QFX5110-48S-4C

Above is part of our test bed network equipment. For more information, Please click [download](#) to get the compatibility test report of each brand of optical transceiver.

Order Information

Part Number	Description
1G-SFP-U35-20	1000BASE-BX SFP BIDI TX-1310nm/RX-1550nm 20km DOM LC SMF Transceiver Module
1G-SFP-D53-20	1000BASE-BX SFP BIDI TX-1550nm/RX-1310nm 20km DOM LC SMF Transceiver Module
1G-SFP-U34-20	1000BASE-BX SFP BIDI TX-1310nm/RX-1490nm 20km DOM LC SMF Transceiver Module
1G-SFP-D43-20	1000BASE-BX SFP BIDI TX-1490nm/RX-1310nm 20km DOM LC SMF Transceiver Module
1G-SFP-U35-40	1000BASE-BX SFP BIDI TX-1310nm/RX-1550nm 40km DOM LC SMF Transceiver Module
1G-SFP-D53-40	1000BASE-BX SFP BIDI TX-1550nm/RX-1310nm 40km DOM LC SMF Transceiver Module
1G-SFP-U45-80	1000BASE-BX SFP BIDI TX-1490nm/RX-1550nm 80km DOM LC SMF Transceiver Module
1G-SFP-D54-80	1000BASE-BX SFP BIDI TX-1550nm/RX-1490nm 80km DOM LC SMF Transceiver Module

Further Information

 | Lighting the Path to Global Links

 **Web** | www.lsolink.com

 **Email** | For Sales@lsolink.com

Disclaimer

1. We are committed to continuous product improvement and feature upgrades, and the contents contained in this manual are subject to change without notice.
2. Nothing herein should be construed as constituting an additional warranty.
3. LSOLINK assumes no responsibility for the use or reliability of equipment or software not provided by LSOLINK. Copyright LSOLINK.COM All Rights